

LIGHTING
YOUNGKONG



2 0 2 4

OPEN YOUR LIGHT





CONTENTS

	On-ground Luminaire Bollard Luminaire
12	DIANE
	Bollard Luminaire
15	AYLA
	The Modular Pole System
18	POLESTAR
	Linear System
24	PENCIL PLUS
	Linear System
27	PENCIL AIR

The History and Future of Youngkong Lighting

Youngkong Lighting is one of the best manufacturing companies which is well experienced and specialized in outdoor and landscape lighting for 40 years.

In 1984, Youngkong Lighting has started the interior lighting business and in the late 1980s, the product quality department was established to manage the permission of electrical products and its certificates to meet the electrical standards by improving the quality products.

In the early 1990s, a research and development team was set up to focus on developing the lighting fixtures on its own. As one of the fast-growing manufacturing companies, a high-tech computerized system was introduced to improve the overall management system of manufacturing and sales. In the late 1990s, the company moved its new headquarters to Yangpyeong-dong, Seoul and automated the assembly line to raise the efficiency of production.

In the early 2000s, Youngkong lighting had a great and short-term achievement by obtaining more than 100 patents and certificates of design and utility model registration. With extensive experience and technologies for the light and luminaire, Youngkong lighting has successfully transformed the business field from interior to outdoor products and started developing outdoor and landscape lighting products professionally.

In 2017, by establishing Research and Development Center, skillful engineers were teamed up to develop the products with advanced technology and improve the Youngkong's own design identity. The sales have widely increased and expanded to the public procurement market. Starting from 2014, Youngkong participated in a light+building exhibition in Frankfurt, resulting in export sales all over the world and the distribution right to India and Hong Kong in 2018.

In 2020, as a part of the investment of the facility for high-quality products, Youngkong lighting has established its own Reliability Assessment Center and introduced the goniophotometer. A large number of products were re-designed and discontinued in order to meet the LED's characteristics. And, new products adopting the latest Youngkong's technology are released instead. Now, Youngkong lighting is well organized with the smart factory adopting a new advanced system of enterprise resource planning to optimize the factory operation and management to provide the best service and grow in the long-term together with customers.

The outdoor lighting luminaires are currently changing their formation not just to be the lighting to illuminate the space but also to be the smart lighting communicating with people and their environment. To become one of the leading companies in the global lighting industry, Youngkong has continued to invest in smart technology and human resources to deliver a higher service value for the bright future. Youngkong lighting will become a recognized leading company in the world market as a group of "Outdoor Lighting Specialist".

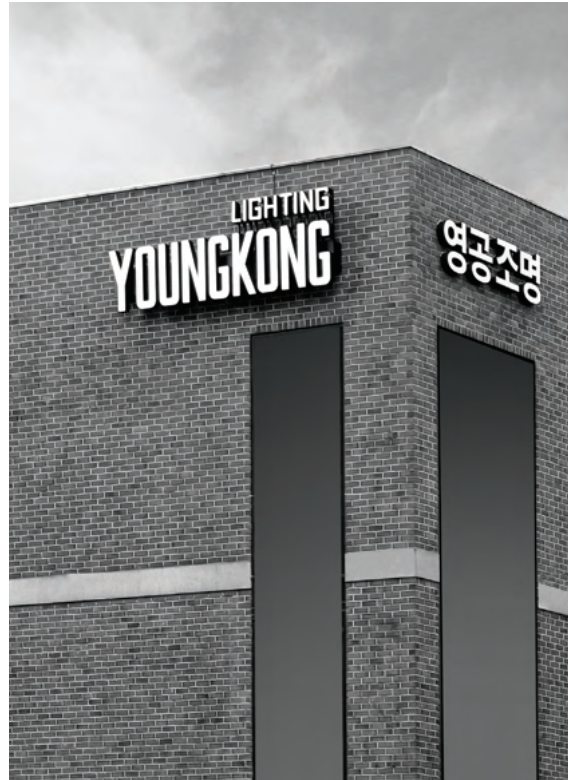

History of Participation in Overseas Fairs and Seminars

Light + Building Exhibition, Frankfurt, Germany 2014 / 2016 / 2018 / 2022



ACETECH Mumbai 2023, Mumbai, India



Lights in Goa 2024, Mumbai, India



Innovation and Technology of Youngkong Lighting

Youngkong Lighting is the most innovative manufacturing company that values research and development with the enthusiasm for high-end quality products. With over 40 years of technical experience and manufacturing know-how, the engineers are studying variable cases in outdoor environments such as humidity, temperature change, heat dissipation, LED circuit and more other things to meet the most durable product design and structure. All outdoor lighting luminaires we're manufacturing are systematically managed by the revision number reflecting any specification change of technical design and its performance. The revision number will be stated in the specification.

We strongly believe that only the design specialized in the outdoor environment makes it possible for the premium brand quality and all we're committed to making our best efforts to continue the steady research and development. We're always working on our best knowledge to be at the best level of our highest integrity and responsibility to create more practical, innovative and the most competitive products accommodating the brilliant ideas of the lighting consultants and architectural designers. We're ready to move forward to make our a reliable product and build a high-quality lighting brand to meet every new requirement in the market. We are making our best efforts in order to create exceptionally outstanding products that can be made only by "Youngkong lighting"

The market of smart lighting integrated with IoT technology will broadly extend from indoor to the outdoor areas. Youngkong will be in line with swift change for the 4th Industrial Revolution representing remote sensing, internet of things, artificial intelligence and network technology. Youngkong will be the best "lighting solution provider" in the future of the smart city.

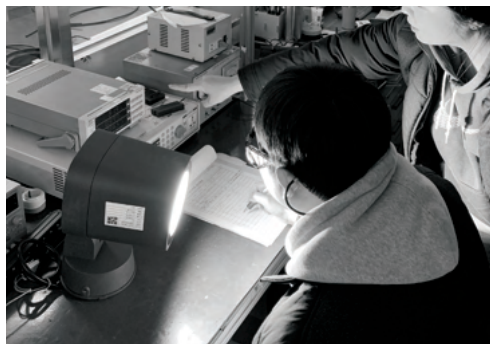

Certification



Korean Intellectual Property Office

Patent / [Registration No: 10-2235017] and other 3 Registration
Design / [Registration No: 30-0782115] and other 47 Registration



Government of India Trade marks registry

Trade Mark No. 3428567



Quality Management System Certification

KS Q ISO 9001:2015 / ISO 9001:2015 / [Certificate No: KQC-5272]

The Design/Development and Production of Fluorescent Lights, Incandescent Lights, LED Indoor Lights, Down Lights, LED Down Lights, Street Lights, LED Street Lights, Security Lights, LED Security Lights, Tunnel Lights, LED Tunnel Lights, Landscape Lights, LED Landscape Lights, Flood Lights, LED Flood Lights, Submersible Lights, LED Submersible Lights, Ground Lights, LED Ground Lights, Solar Street Lights, Hybrid Street Lights, LED Sensor Lights



Bureau of Indian Standards

Fixed General Purpose LED luminaires / [Certificate No: R-41168130]
LED luminaires for Road and Street Lighting / [Certificate No: R-41189316]



Korean Industrial Standards

KS C 7713 / LED landscape lighting [Certificate No: 16-0203]
KS C 7711 / LED inground lighting [Certificate No: 16-0407]
KS C 7716 / LED tunnel lighting [Certificate No: 16-0608]
KS C 7657 / LED sensor luminaires [Certificate No: 17-0257]
KS C 7658 / LED luminaires for road, street and area lighting [Certificate No: 13-5198]
KS C 7712 / LED flood-lighting luminaires [Certificate No: 22-0107]
KS C 7653 / LED recessed and fixed luminaires [Certificate No: 14-0511]



Electrical Appliances Safety Certificate

LED luminaires / [HA11239-21006A] and other 1 certificate



Registration of Broadcasting and Communication Equipments

LED luminaires / [R-R-yK1-3270] and other 87 certificate



Certificate Of High Efficiency Energy Using Appliance

LED luminaires / [Luminaires 33024] and other 13 certificate

Project References



Seoul National University Main Gate Square, Korea



Gimpo International Airport, Korea



EXPO Science Park, Korea



Incheon International Airport Terminal 2, Korea



The Hyundai Seoul Department Store, Korea



Lotte Resort Sokcho, Korea



Private Villa, Chandigarh, India



Modern Heritage in Seoul Noryangjin Underground Sewer, Korea



MARU 180 Cafe, Korea



Residence Villa 37, Chandigarh, India



Shinsegae Department Store, Korea



Hyundai THE-H Apt. Complex, Banpo, Korea

NEW

On-ground Luminaire | Bollard Luminaire

DIANE

DIANE combines with one art objet in a variety of environments, including beautifully decorated parks with flowers and trees, architectural museums with modern structures and monuments.



ATTRACTIVE LIGHT

DIANE offers seamless visual comfort of the light distribution to give joy in a safe environment at night. The beautiful lighting illuminated on the ground ideally suits your mood and needs by delivering the meaning in your space.

UNIQUE DESIGN

DIANE embodies the pursuit of perfection balance and harmony. The architectural shape and proportion blend naturally into the surroundings and reveal its presence as an art objet.

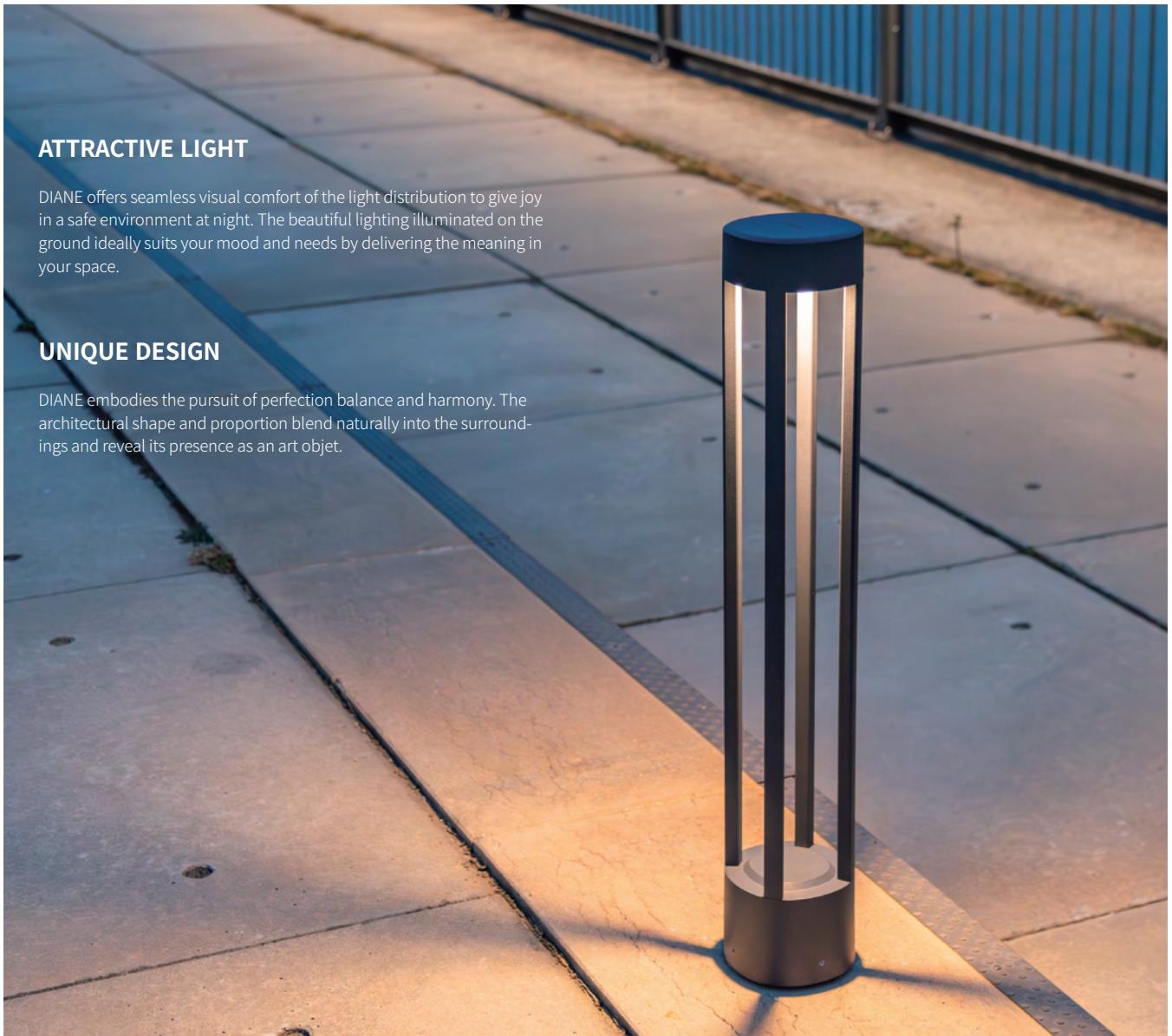

SPECIFICATION

Power consumption	5W	Power factor	≥0.90
Luminaire efficacy [based on 3000K, 780mm(H)]	75 lm/W	Power supply	Integral driver
Color temperature	3000K, 4000K	Finish	Dark gray (powder-coated) color Stone gray (powder-coated) color
CRI	Ra ≥ 80	Ingress protection	IP67
Input voltage	220~240Vac 50~60Hz	Size[mm]	135(W) x 235/500/780(H) x 135(D)

DRAWING

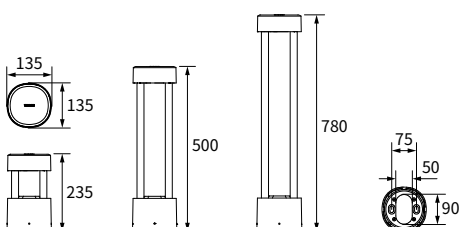

INSTALLATION ACCESSORY



Spike

- Material: Aluminum
- Finish: Powder coating(dark gray)
- Used for 235mm(H)

PHOTOMETRIC DATA

Grid distance 0.5m

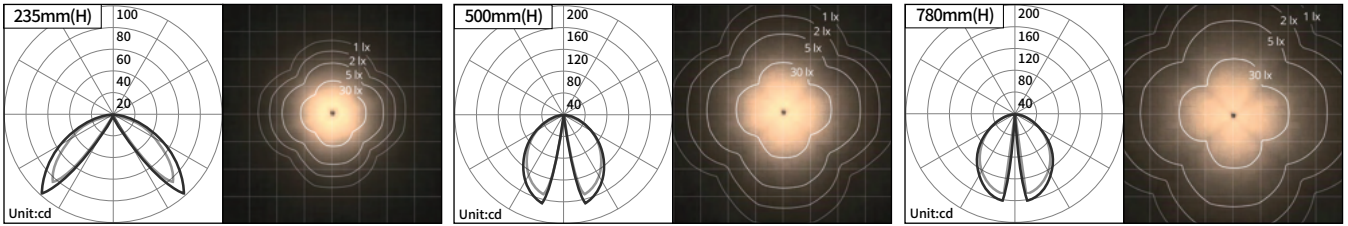

IP67 STRONG PROTECTION



To maintain high durability, it must be perfectly protected from water and dust from the outside. With its high IP67 rating, DIANE will stay safe for a long time in a rapidly changing climate and in a variety of adverse environments.

PERFECT DURABILITY



DIANE boasts strong durability. The GORE® Protective Vent was applied to circulate the air inside and outside the lighting to prevent deformations that cause component failure and to ensure long-lasting lighting performance. With its robust durability, DIANE will stand firm in any environment and light up your life in style.

TWO(2) AVAILABLE FINISH OPTIONS

Dark Gray Color

Stone Gray Color



NEW

Bollard Luminaire

AYLA

“gentle light for your own darkness”

Presenting AYLA, the inaugural outcome of a 2024 collaborative venture with NEHTE lost & finding, a professional lighting design studio. Crafted by NEHTE's chief designer, YEUNE KYUE KIM, AYLA seamlessly integrates soft illumination and natural contours.

 *nehTE*
lost & finding X LIGHTING YOUNGKONG



NATURAL DESIGN

Round head, slanting lines, with imaginary roots deeply in the ground. Light gently directed towards the earth, casting a soft and warm glow. The natural colors of the earth absorb and reflects its own light, creating a presence always in harmony with the surrounding plants and gentle breeze.



SPECIFICATION

Power consumption 5W, 5W(Soft glow)

Luminaire efficacy 25 lm/W, 6 lm/W (Soft glow)
[based on 3000K]

Color temperature 3000K, 4000K

Bin/Step 3-step MacAdam ellipse

CRI Ra ≥ 90

Input voltage 220~240Vac 50~60Hz

Power factor ≥0.90

Power supply Integral driver

Finish Stone gray (powder-coated) color
Dark gray (powder-coated) color

Ingress protection IP66

Size[mm] Ø106(W) x 605/905(H)

DRAWING

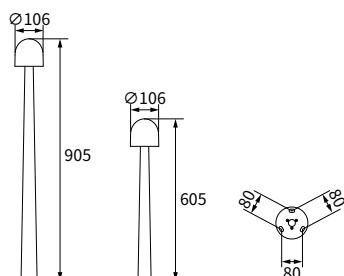

INSTALLATION ACCESSORY

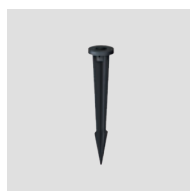

Spike

- Material: Aluminum
- Finish: Powder coating(dark gray)

PHOTOMETRIC DATA

5W

Grid distance 0.35m

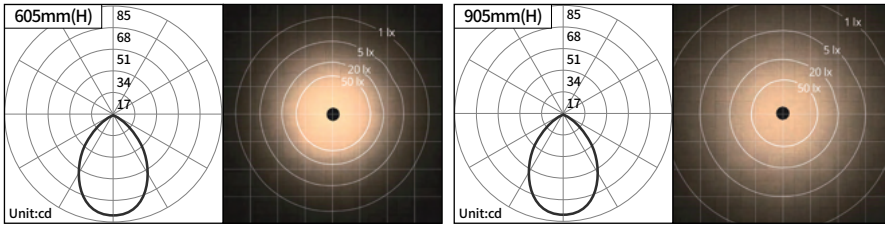

5W(Soft glow)

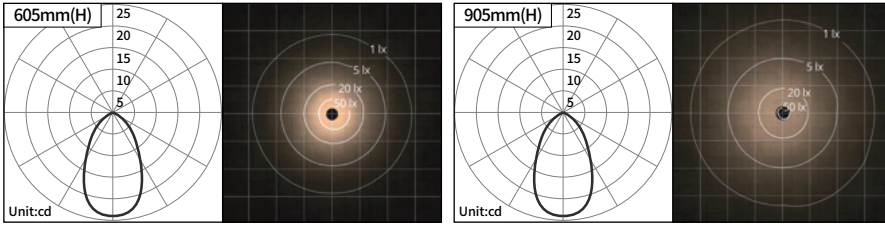

IP66 STRONG PROTECTION



To maintain high durability, it must be perfectly protected from water and dust from the outside. With its high IP66 rating, AYLA will stay safe for a long time in a rapidly changing climate and in a variety of adverse environments.

PERFECT DURABILITY



AYLA boasts strong durability. The GORE® Protective Vent was applied to circulate the air inside and outside the lighting to prevent deformations that cause component failure and to ensure long-lasting lighting performance. With its robust durability, AYLA will stand firm in any environment and light up your life in style.



The Modular Pole System

POLESTAR

Multiple and block-layered lighting solutions.

* Patent / [Registration No: 10-2635937]
Korean Intellectual Property Office





TWO(2) AVAILABLE MODULE OPTIONS

Choose the best mounting application for the user requirements.

Base module for easy mounting and configuration of lighting fixtures and additional devices.

Recessed module for more compact sized design pole that represents the modern architectural lighting.

Base Module Recessed Module



WHATEVER AND WHEREVER YOU NEED

Free positioning of floodlights, security lights, CCTV, speaker, direction and sign board and more.



- 360° FREE ROTATION
- STRUCTURAL STABILITY

It's structurally safe for multiple stacking of modules with a vertical mounting based on a disk-kit type coupling that also prevents the formation of dislocation.



ADJUSTABLE HEIGHT

Adjustments to the height of poles can be freely changed with the standardized connecting pole.

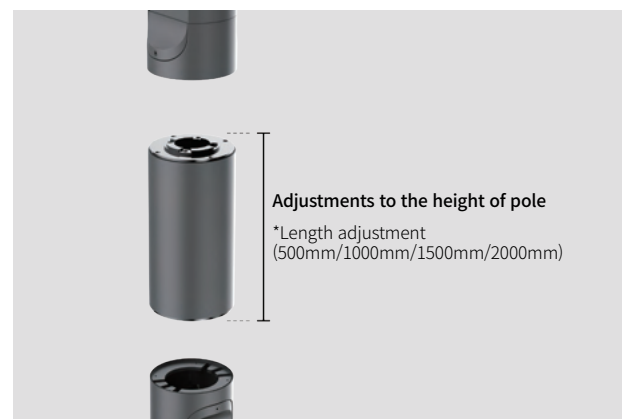



BASE MODULE

1. Optional Pole Height

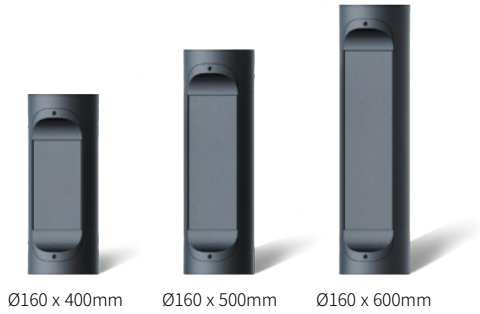

2. Configuration

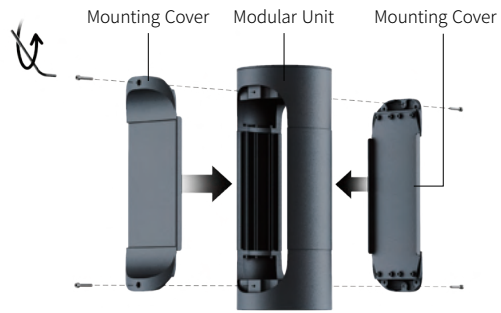

3. Easy and Quick Mounting

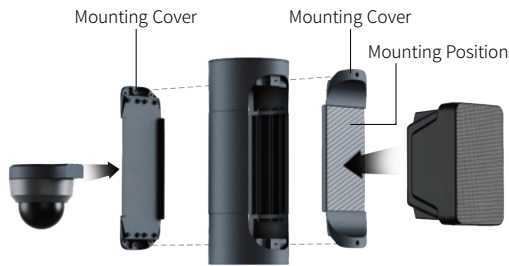

4. Optimal Display for Pole Luminaires

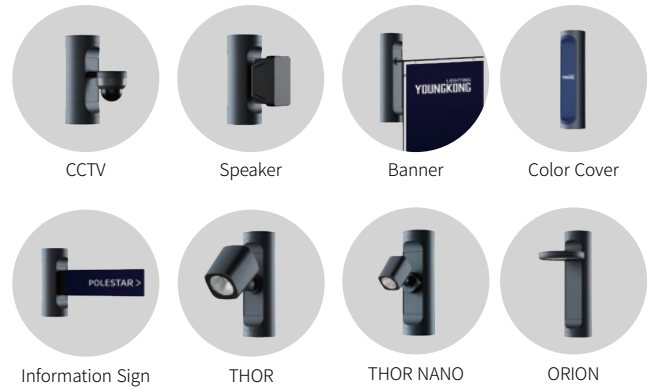

LIGHTS FOR BASE MODULE



ORION

- 50W, 60W
- 3000K, 4000K, 5000K
- 3-step MacAdam ellipse
- 130 lm/W (50W, 3000K)
- Integral driver (Inside the pole)
- IP66



THOR

[Module Mounting Type]

- COB 40W, 60W
- spot, 15°, 20°, 36°, 68°
- 3000K, 4000K, 5000K
- 3-step MacAdam ellipse
- 123 lm/W (40W, 3000K, 68° Optic)
- Integral driver (Inside the product)
- IP66



THOR NANO

[External Connection Type]

- COB 14W
- 15°, 30°, 60°
- 3000K, 4000K, 5000K
- 3-step MacAdam ellipse
- 118 lm/W (3000K, 60° Optic)
- Integral driver (Inside the product)
- IP66



RECESSED MODULE

1. Optional Pole Height



2. Configuration

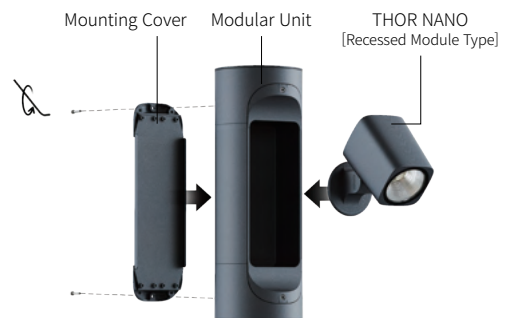

LIGHTS FOR RECESSED MODULE



THOR NANO

[Recessed Module Type]

- COB 14W, 30W, 40W
- 15°, 30°, 60°
- 3000K, 4000K, 5000K
- 3-step MacAdam ellipse
- 117 lm/W (14W, 3000K, 30° Optic)
- 14W integral driver (Inside the product)
- 30W, 40W integral driver (Inside the pole)
- IP66



NEW

Linear System

* Patent / [Registration No: 10-2235017]
Korean Intellectual Property Office

PENCIL PLUS ⁺

PENCIL PLUS provides high-efficiency LEDs and it elevates a variety of light distribution options including asymmetrical optics.



Strong
Protection



LED Available
with RGBW

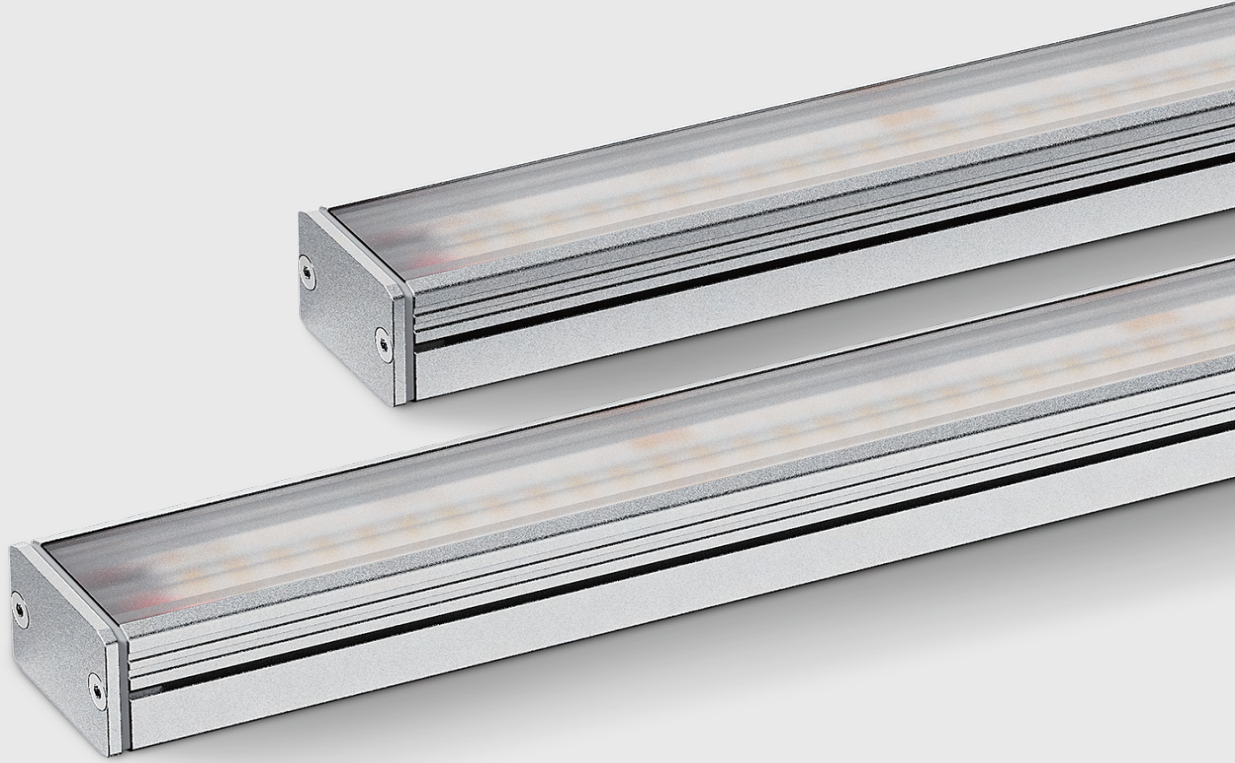

SPECIFICATION

Power consumption	8W/M, 16W/M, 24W/M
Color temperature	3000K, 4000K, 5000K, RGBW (4in1 / W=4000K)
Bin/Step	3-step MacAdam ellipse (3000K, 4000K, 5000K)
CRI	Ra ≥ 90 (3000K, 4000K, 5000K)
Optics	· White: 40°x100°, 90°x100°, Asymmetric Wallwash · RGBW: 90°x100°

Input voltage	24 Vdc
Power supply	Remote driver
Finish	Shot blast + Silver anodized
Ingress protection	IP67
Size[mm]	517.5/1000(W) x 22.5(H) x 32.5(D)

DRAWING

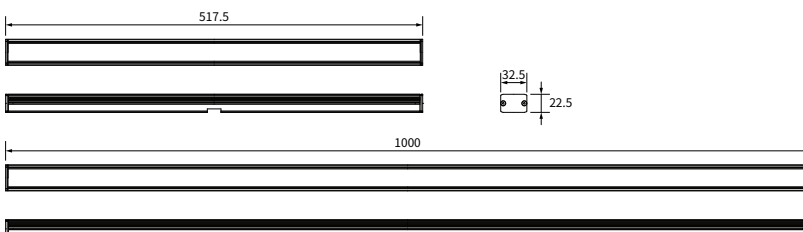

OPTIC OPTIONS

3000K, 4000K, 5000K

RGBW

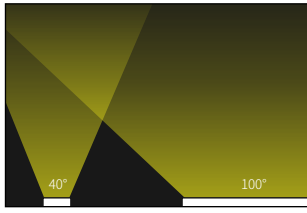

40°x100°

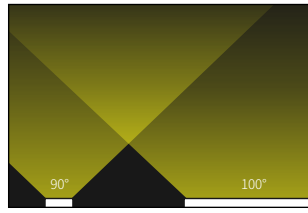

90°x100°

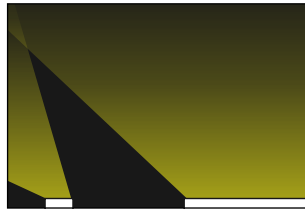

Asymmetric Wallwash

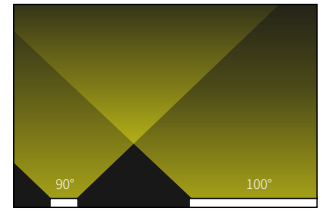

90°x100°

CONSISTENT CCT AND CRI

PENCIL PLUS is systemically designed to maintain the balance of high performance LED lights By reducing the shifting level of CCT(Correlated Color Temperature) and CRI(Color Rendering Index).

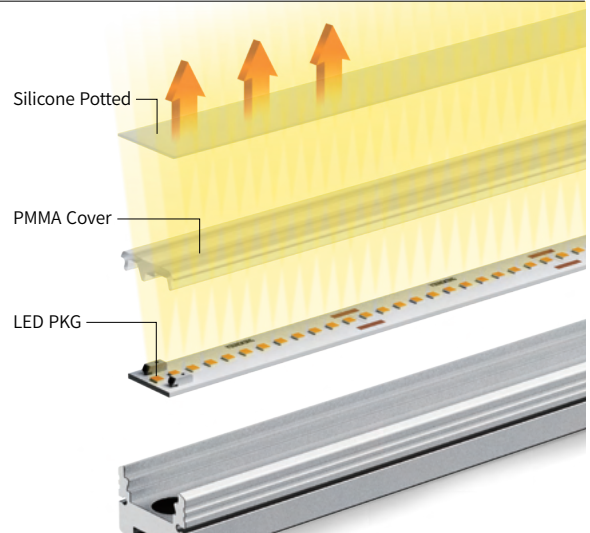

LED LIGHTING COLOR CONSISTENCY

Unlike having the visual deviations of color temperature(K) from a CIE chromaticity diagram, our linear system is designed to ensure and maintain the color consistency of LED lighting within the 3-step MacAdam Ellipse.

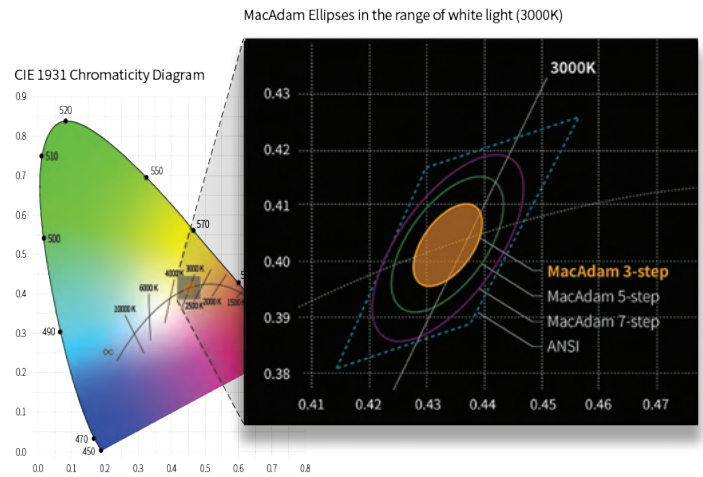

THE PATENTED IP67 LINEAR SYSTEM

By applying our own and unique technology of silicone gasket and a variety of waterproof methods, it perfectly meets the higher protection rating IP67 even though the liner system boasts a compact line up.

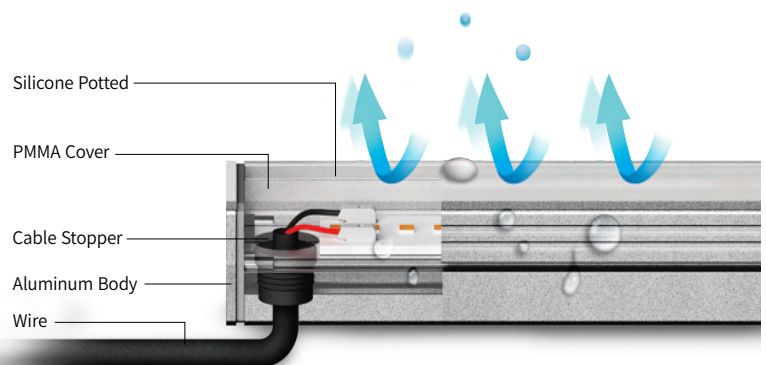

CONNECTOR



- Material: PVC, Nickel Plated Brass
- Wire: White_UL 2464 22AWG PVC Cable
RGBW_UL 2464 24AWG PVC Cable
- IP67

MOUNTING OPTIONS



- L Shape Bracket 1**
- Material: Stainless Steel



- L Shape Bracket 2**
- Material: Stainless Steel



- Adjustable Bracket**
- Material: Stainless Steel



- Mounting Bracket**
- Material: Stainless Steel

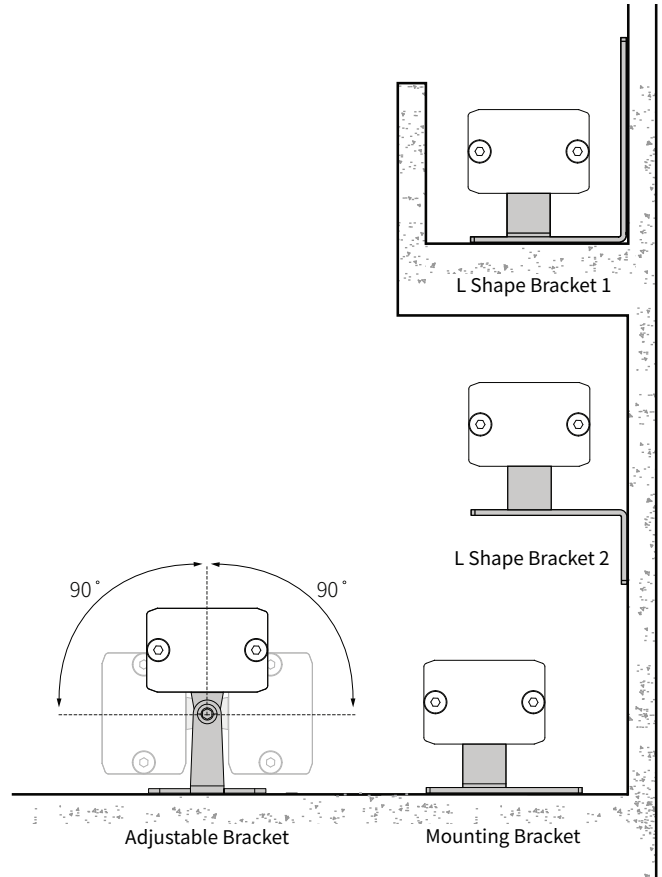

ACCESSORIES



- IP67 Leader Cable Male Connector(500mm)**
- Material: PVC, Nickel Plated Brass
- Wire: White_UL 2464 22AWG PVC Cable
RGBW_UL 2464 24AWG PVC Cable

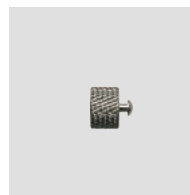

- End Male Cap**
- Material: Nickel Plated Brass

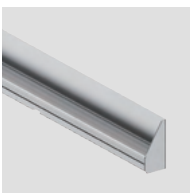

- Masking Plate**
- Material: Aluminum
- Finish: Powder-Coated Color

Linear System

* Patent / [Registration No: 10-2235017]
Korean Intellectual Property Office

PENCIL AIR

PENCIL AIR is a compact linear luminaire using an advanced high-quality LED light source.



Strong
Protection



LED Available
with RGB



SPECIFICATION

Power consumption	8W/M, 16W/M	Cover	Clear/Diffused Polycarbonate
Luminaire efficacy [based on 8W, 1000mm, Clear]	124 lm/W	Power supply	Remote driver
Color temperature	3000K, 4000K, 5000K, RGB	PCB increment	98mm
CRI	Ra ≥ 80 (3000K, 4000K, 5000K)	Finish	Shot blast + Silver anodized
Input voltage	24 Vdc	Ingress protection	IP66
		Size[mm]	510/1000(W) x 15(H) x 18.6(D)

DRAWING

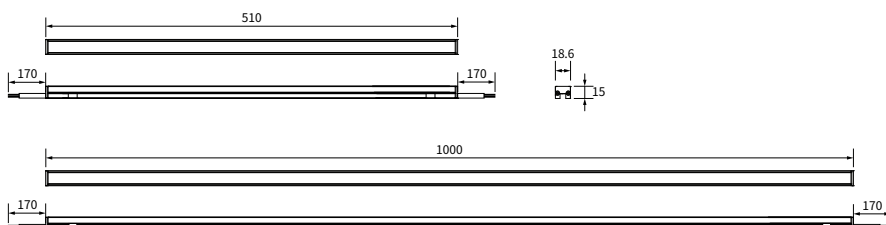

PHOTOMETRIC DATA

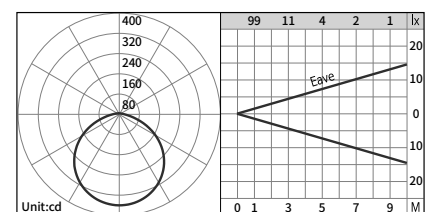

8W, 1000mm(W), Clear

3-WAY WIRE CONNECTION

Easy and convenient access to cable connection and wiring due to the structural design of the lighting body for the user environment.

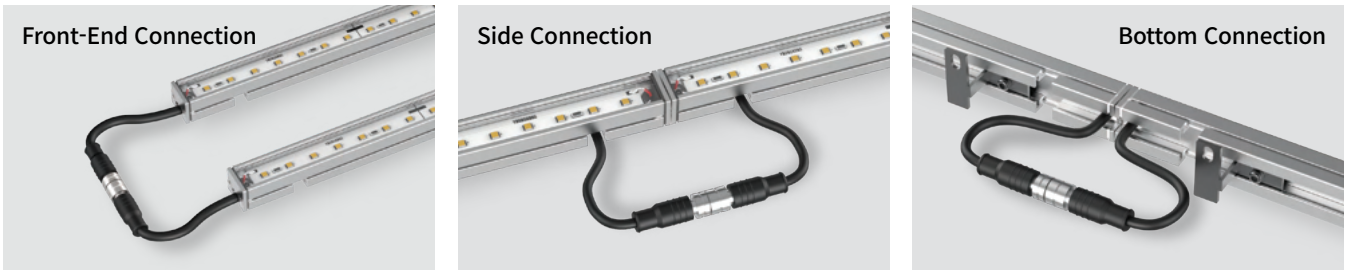

MOUNTING OPTIONS



Self Adhesive Tape
430mm / 920mm



Mounting Clip
- Material: Stainless Steel



Mounting Bracket
- Material: Stainless Steel

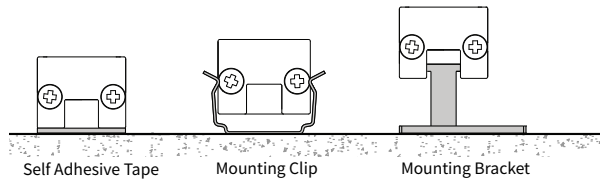

ACCESSORIES

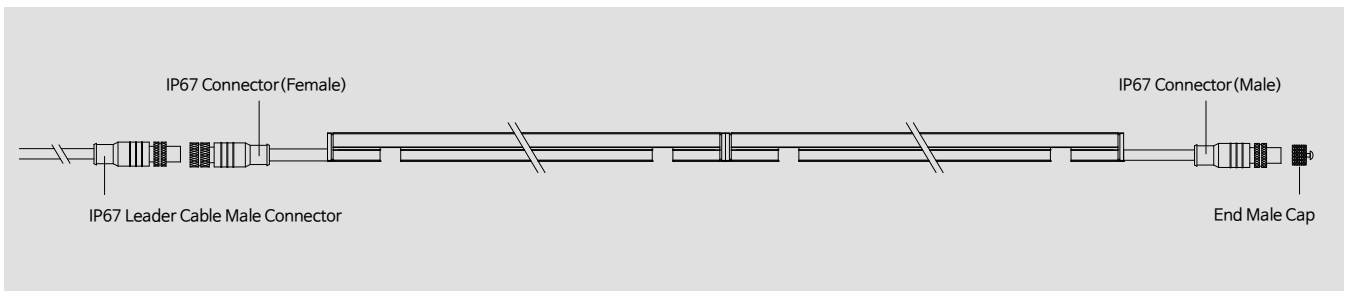

IP67 Connector(Female+Male)
- Material: PVC, Nickel Plated Brass
- Wire: UL 2464 22AWG PVC Cable



IP67 Leader Cable Male Connector(500mm)
- Material: PVC, Nickel Plated Brass
- Wire: UL 2464 22AWG PVC Cable

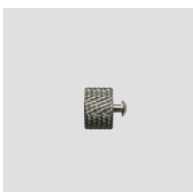

End Male Cap
- Material: Nickel Plated Brass



Masking Plate
- Material: Aluminum
- Finish: Powder-Coated Color

CONSISTENT CCT AND CRI

PENCIL AIR is systemically designed to maintain the balance of high performance LED lights By reducing the shifting level of CCT(Correlated Color Temperature) and CRI(Color Rendering Index).

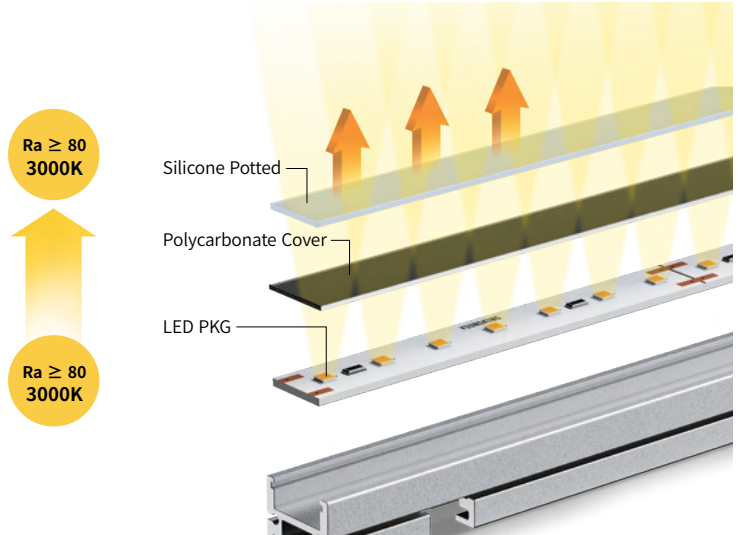

SEAMLESS LED LINEAR LIGHT

The optimal structure design makes the seamless light effect when the light fixture is close to the surface to be lit.

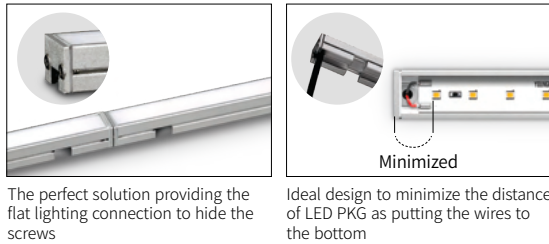

The perfect solution providing the flat lighting connection to hide the screws

Ideal design to minimize the distance of LED PKG as putting the wires to the bottom

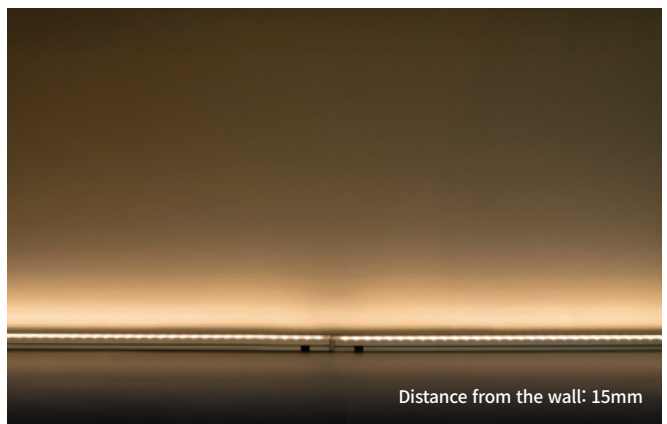

THE PATENTED IP66 LINEAR SYSTEM

By applying our own and unique technology of silicone gasket and a variety of waterproof methods, it perfectly meets the higher protection rating IP66 even though the liner system boasts a compact line up.

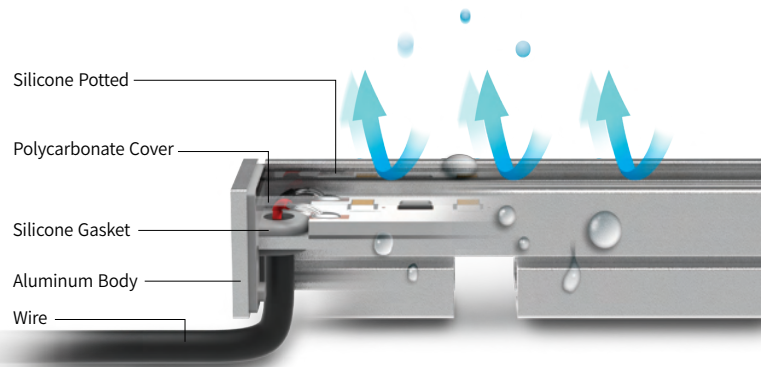

FINISH QUALITY



· **Shot Blast**
A surface treatment technique that makes use of particulate grains propelled at high velocity and makes the surface clean.



· **Silver Anodizing**
An electrochemical process that converts the metal surface into a decorative, durable, corrosion-resistant, anodic oxide finish.



PENCIL AIR MOLD

Easy Angle Adjustment with Upper Mold

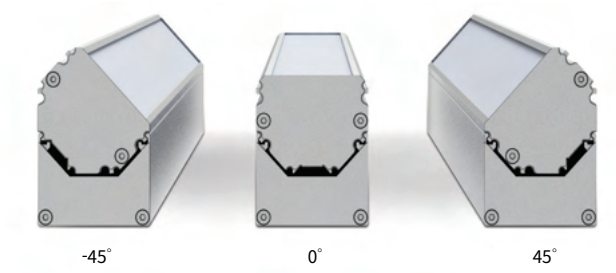

Innovative Solution for Wiring

Designed to facilitate wiring for installation and enhance visual comfort with the secondary diffuser.

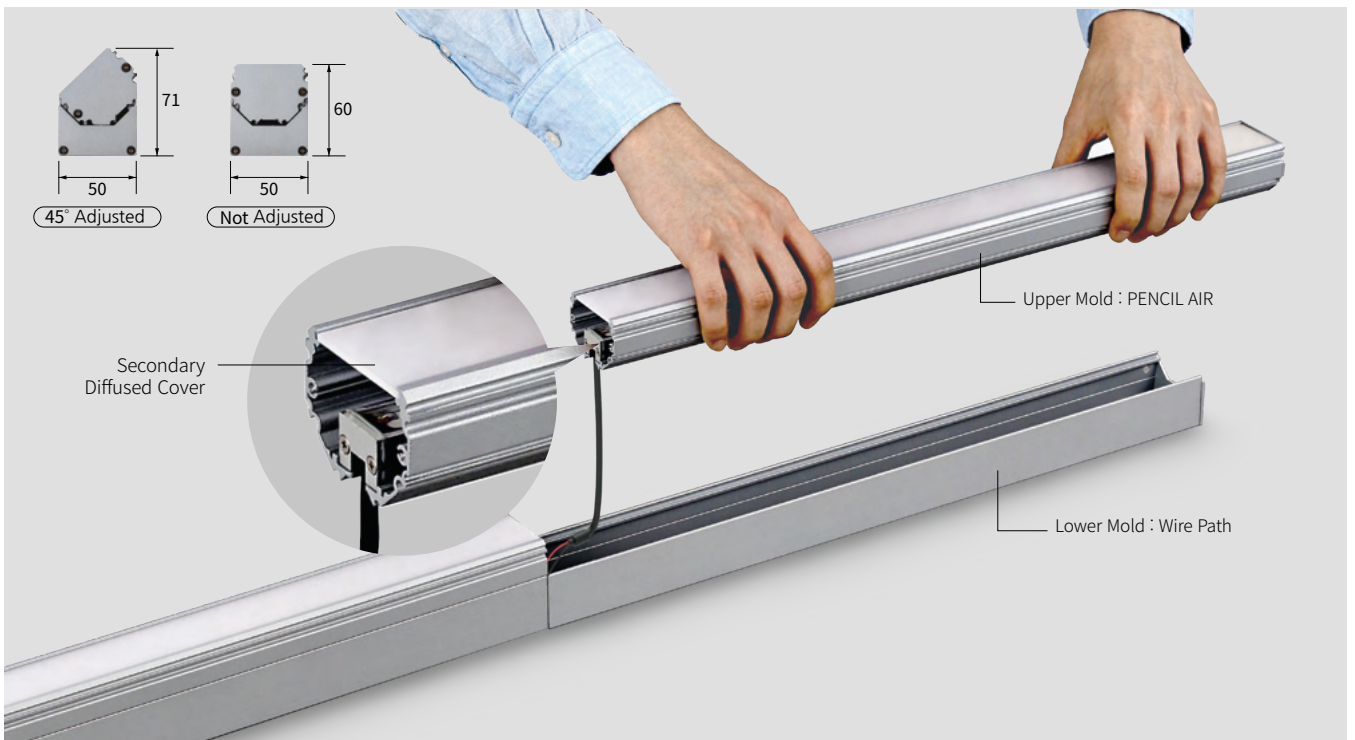



LUNA X Country Club, Korea



Ananti at Gangnam, Korea



HEAD OFFICE & FACTORY:
YOUNGKONG LIGHTING CO., LTD.
146, Yangpyeong-ro, Yeongdeungpo-gu
Seoul, 07204, KOREA

TEL: +82-2-2629-2025
FAX: +82-2-2629-2090

info@youngkong.com
eng.youngkong.com





LIGHTING
YOUNGKONG | OUTDOOR LIGHTING
SPECIALIST